

# **INTIPRDSVW Series User's Manual**

**V1.1.0**

# Table of Contents

Table of Contents.....	2
1 Product Overview .....	1
1.1 List of Models.....	1
1.2 Structure .....	1
1.2.1 Structure .....	1
1.2.2 Front Panel .....	2
1.2.3 Rear Panel.....	3
1.3 Networking Scene.....	3
1.3.1 One-to-One Scene.....	3
1.3.2 Group Call Scene.....	4
2 Install VTO.....	5
2.1 Direct Installation.....	5
2.1.1 Screw.....	5
2.1.2 Dimension.....	5
2.1.3 Installation Step .....	6
2.2 Embedded in Wall.....	8
2.2.1 Screw.....	8
2.2.2 Dimension.....	9
2.2.3 Installation Step .....	9
2.3 Wiring.....	11
2.4 Electric Control Lock and Electromagnetic Lock.....	12
2.4.1 Electric Control Lock .....	12
2.4.2 Electromagnetic Lock.....	12
3 Installation Debugging .....	1
3.1 Modify IP Address .....	1
3.2 General Config.....	2
4 Web Config.....	1

4.1	System Config.....	1
4.1.1	Local Config.....	1
4.1.2	LAN Config .....	4
4.1.3	Indoor Manager.....	4
4.1.4	Network Config .....	5
4.1.5	Video Set .....	7
4.1.6	User Manage .....	8
4.2	IPC.....	10
4.3	Info Search.....	10
4.3.1	Call History .....	10
4.3.2	Alarm Record .....	11
4.3.3	Unlock Record .....	11
4.4	Status Statistics .....	12
4.4.1	VTH Status .....	12
4.5	Logout.....	12
5	Basic Function Introduction.....	13
5.1	Call Function .....	13
5.1.1	Call Resident.....	13
5.1.2	Group Call.....	13
5.2	Monitor.....	16
5.3	Unlock Function .....	16
5.4	Compensation of Light .....	16
5.5	Vandal Proof .....	17
5.6	Restore Backup .....	17
6	FAQ.....	18
	Appendix 1 Technical Specifications .....	19
	Appendix 2 Accessories .....	1
	Appendix 2.1 Cable Specification .....	1
	Appendix 2.2 Power Extension Line Specification .....	1
	Appendix 2.3 Embedded Box .....	1

## **Important Safeguards and Warnings**

Please read the following safeguards and warnings carefully before using the product in order to avoid damages and losses.

Note:

- Do not expose the device to lampblack, steam or dust. Otherwise it may cause fire or electric shock.
- Do not install the device at position exposed to sunlight or in high temperature. Temperature rise in device may cause fire.
- Do not expose the device to humid environment. Otherwise it may cause fire.
- The device must be installed on solid and flat surface in order to guarantee safety under load and earthquake. Otherwise, it may cause device to fall off or turnover.
- Do not place the device on carpet or quilt.
- Do not block air vent of the device or ventilation around the device. Otherwise, temperature in device will rise and may cause fire.
- Do not place any object on the device.
- Do not disassemble the device without professional instruction.

Warning:

- Please use battery properly to avoid fire, explosion and other dangers.
- Please replace used battery with battery of the same type.
- Do not use power line other than the one specified. Please use it properly. Otherwise, it may cause fire or electric shock.

## **Special Announcement**

- This manual is for reference only.
- All the designs and software here are subject to change without prior written notice.
- All trademarks and registered trademarks are the properties of their respective owners.
- If there is any uncertainty or controversy, please refer to the final explanation of us.
- Please visit our website for more information.

# 1 Product Overview

## 1.1 List of Models

Model	Chassis Material	Color	Unlock via IC card	Button Type	Lock Control Module
VTO2000A	Metal	Silver	N/A	Mechanical key	Built-in

## 1.2 Structure

### 1.2.1 Structure

Before installation, please make you sure know the dimensions of device and select appropriate method of installation. See Figure 1- 1.

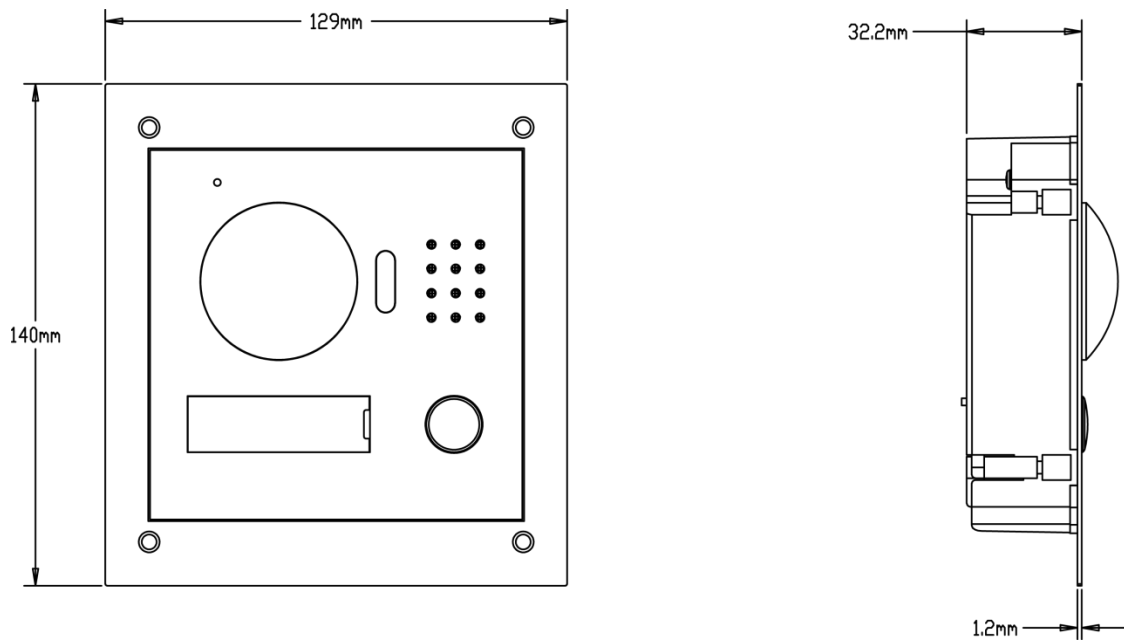

Figure 1- 1

## 1.2.2 Front Panel

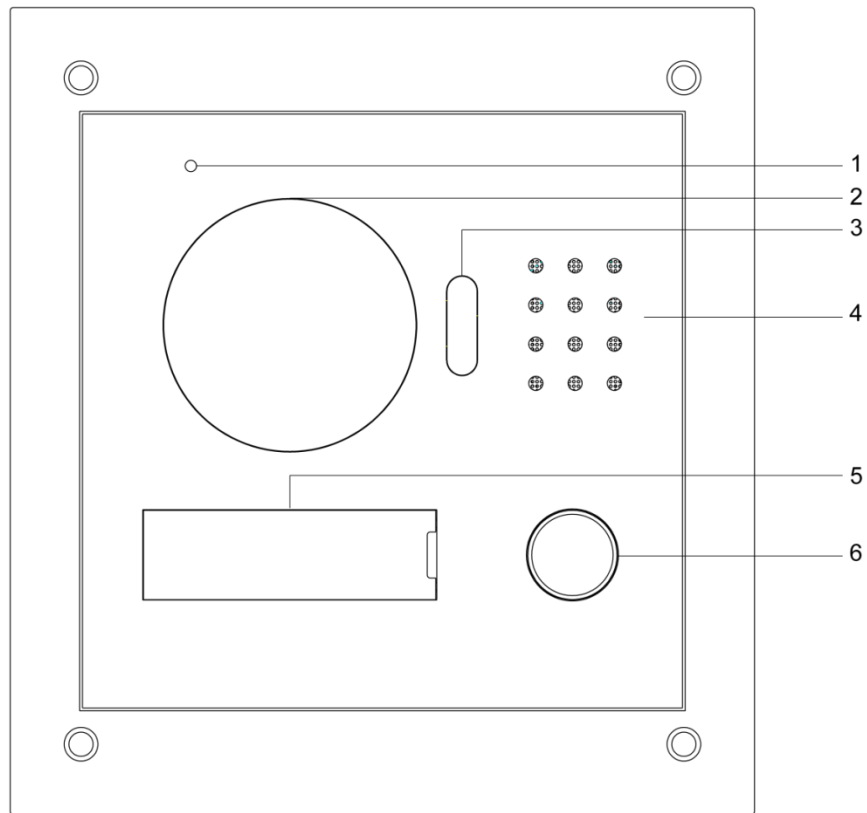

Figure 1- 2

No.	Port Name	Note
1	MIC	Audio input.
2	Camera	It monitors corresponding door region.
3	Compensation Light	Light compensation will automatically turn on during monitoring, calling, or connecting status if there is no enough light in environment.
4	Speaker	Audio output.
5	User Nameplate	Display username and other info.
6	Call Button	Call center or VTH (Intercom Monitor).

### 1.2.3 Rear Panel

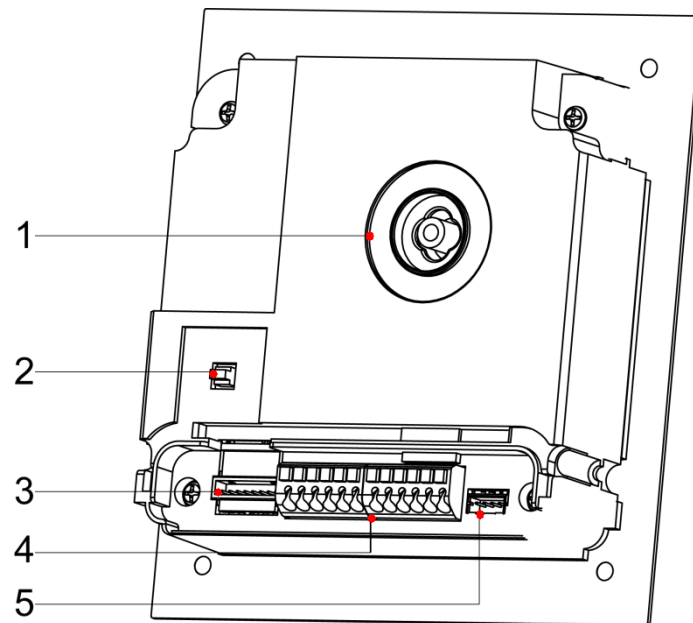

Figure 1- 3

No.	Component Name	Note
1	Camera Angle Adjustment	Adjust camera angle.
2	Vandal-proof Switch	When VTO if forced to leave wall, it will alarm and report to MGT center.
3	Network Port	Via convertor, connect network cable (RJ45 crystal head).
4	User Port	Connect to lock, door sensor feedback and unlock button.
5	Project Port	Reserved for project staff use.

## 1.3 Networking Scene

Here introduces VTO's application scene, please read the following contents and install according to actual condition.

### 1.3.1 One-to-One Scene

Visitor press Call button to call resident ( as VTH). See Figure 1- 4.

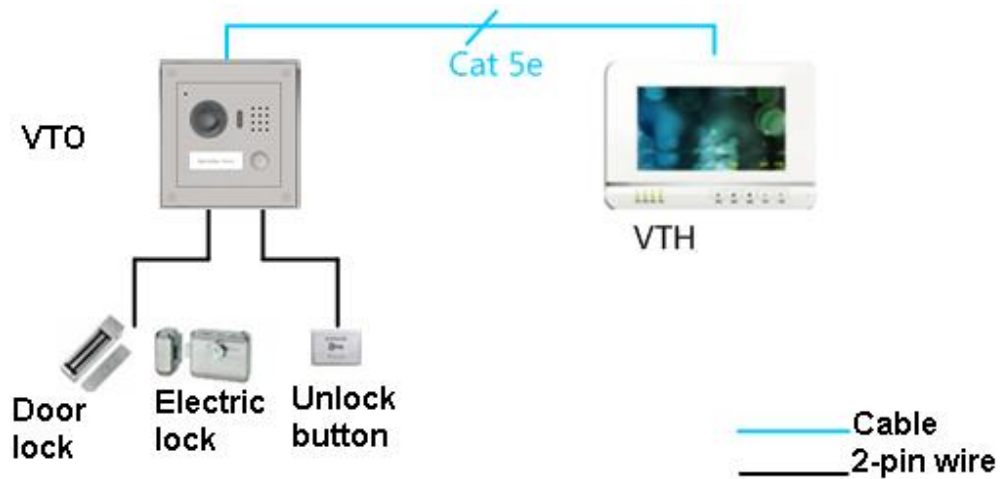

Figure 1- 4

### 1.3.2 Group Call Scene

When visitor press Call on VTO, multiple VTH will ring at the same time. The resident can answer, hang up or unlock door from any of the VTHs.

Note:

VTH has main VTH (host) and sub VTH (extension). One host can have up to 3 extensions.

See Figure 1- 5.

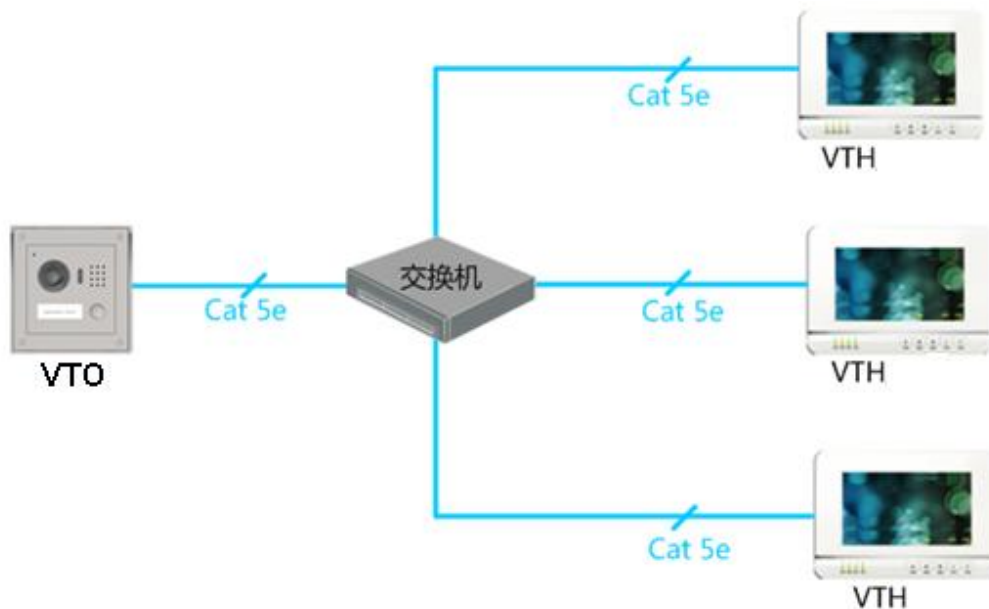

Figure 1- 5

## 2 Install VTO

VTO installation includes direct and embedded wall installation. Direct installation is to install VTO in wall while embedded-wall is to dig a hole on wall and embed VTO into the hole. This chapter separately introduces these two methods.

### 2.1 Direct Installation

#### 2.1.1 Screw

Before installing VTO, please check screws on accessory bag according to the following specifications and install by following this guide.





Component Name	Illustration	Quantity
M3x6 Hex slot pan head tail machine screws --- galvanizing white		4
M3x8 Cross recessed countersunk head tail machine screws --- galvanizing white		4
ST3x18 Cross recessed countersunk head tail tapping screws --- galvanizing white		4
White expansion tube $\varnothing$ 6x30mm		4

Chart 2- 1

Note:

M3x6 or M3x8 either is OK.

#### 2.1.2 Dimension

Before you install the device, please make sure you know the dimension of device and select appropriate installation method. See Figure 2- 1.

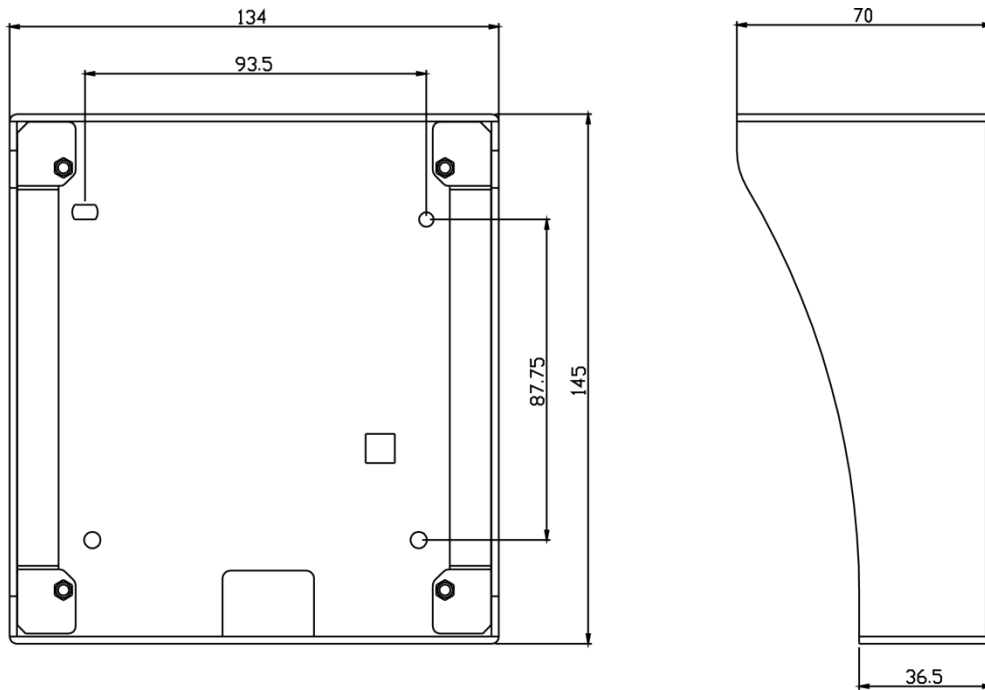

Figure 2- 1

### 2.1.3 Installation Step

- Step 1. Install metal bracket into the groove on wall. Fasten screw (ST3×18 Cross recessed countersunk head tail tapping screws --- galvanizing white), and fix metal bracket on wall. See Figure 2- 2
- Step 2. Align the device on metal bracket according to screw hole. Fasten screw (M3×8 Cross recessed countersunk head tail machine screws --- galvanizing white), and fix device on metal bracket. See Figure 2- 3.

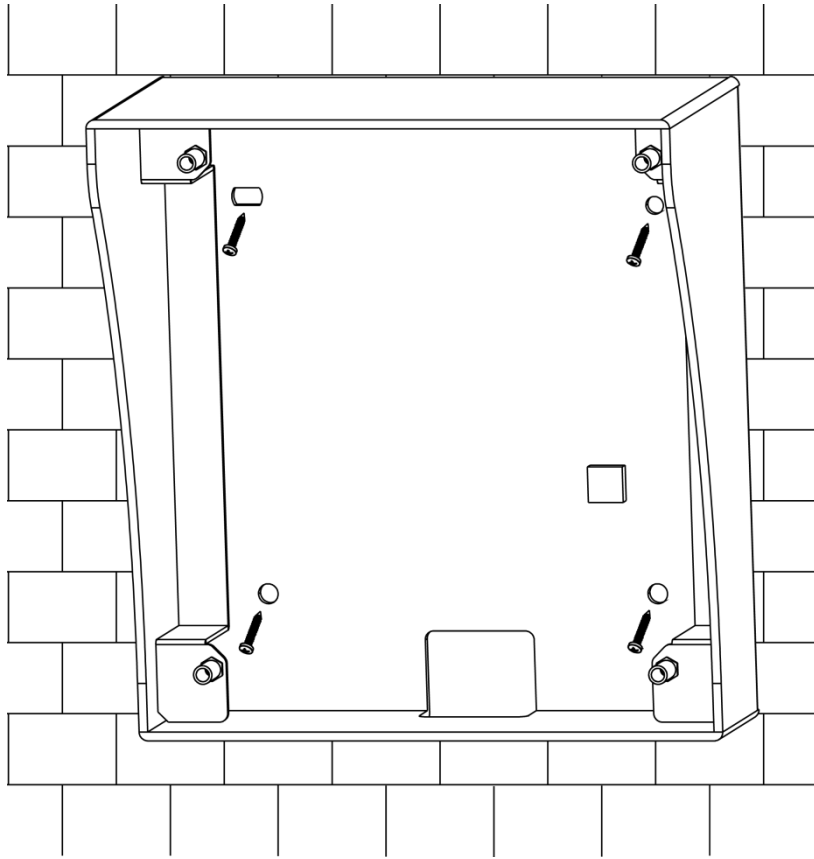

Figure 2- 2

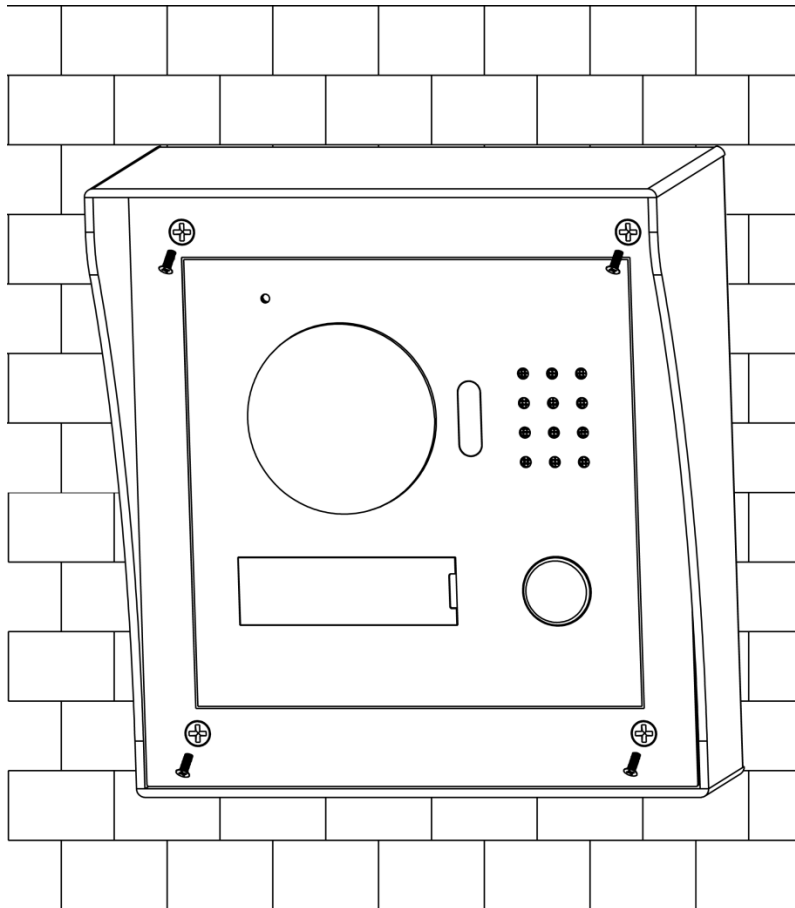

Figure 2- 3

## 2.2 Embedded in Wall

### 2.2.1 Screw

Before installing VTH, please check screws on accessory bag according to the following specifications and install by following this guide.



Component	Illustration	Quantity
M3x6 Hex slot pan head tail machine screws--- galvanizing white		4
M3x8 Cross recessed countersunk head tail machine screws --- galvanizing white		4

Chart 2- 2

Note:

M3x6 or M3x8 either is OK.

## 2.2.2 Dimension

Before you install the device, please make sure you know the dimension of device and select appropriate installation method. See Figure 2- 4.

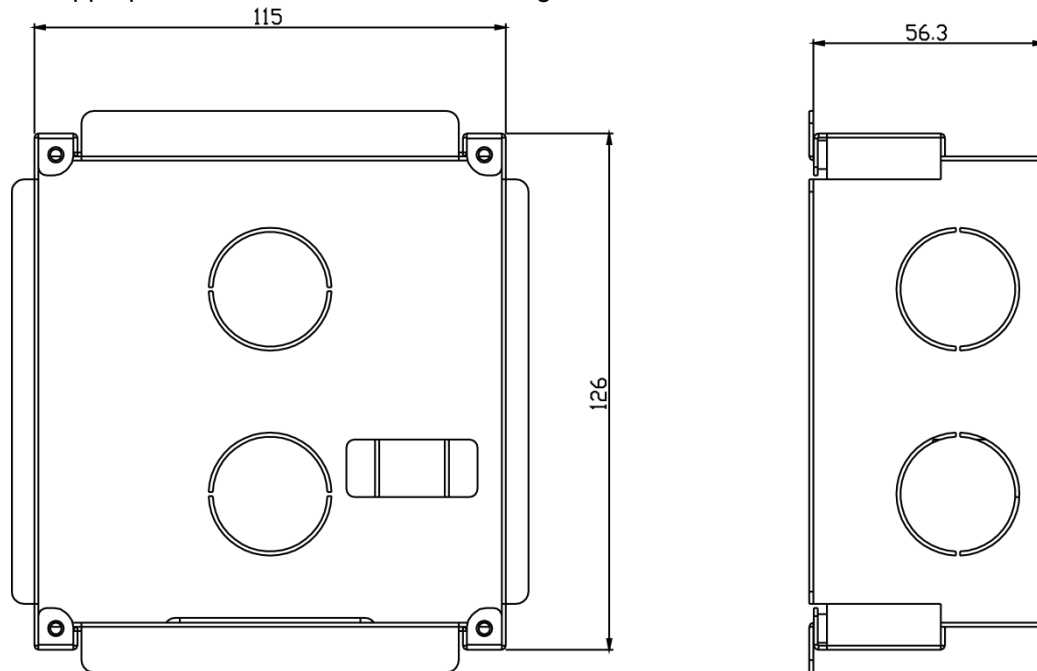

Figure 2- 4

## 2.2.3 Installation Step

- Step 1. Dig a hole on wall, its dimension is 117\*128\*80(mm).See Figure 2- 5.
- Step 2. Embed metal bracket into wall until its four peaks lean against the wall. See Figure 2- 6.
- Step 3. Align the device on metal bracket according to screw hole. Fasten screws (M3×8 Cross recessed countersunk head tail machine screws --- galvanizing white), and fix device on metal bracket. See Figure 2- 7.

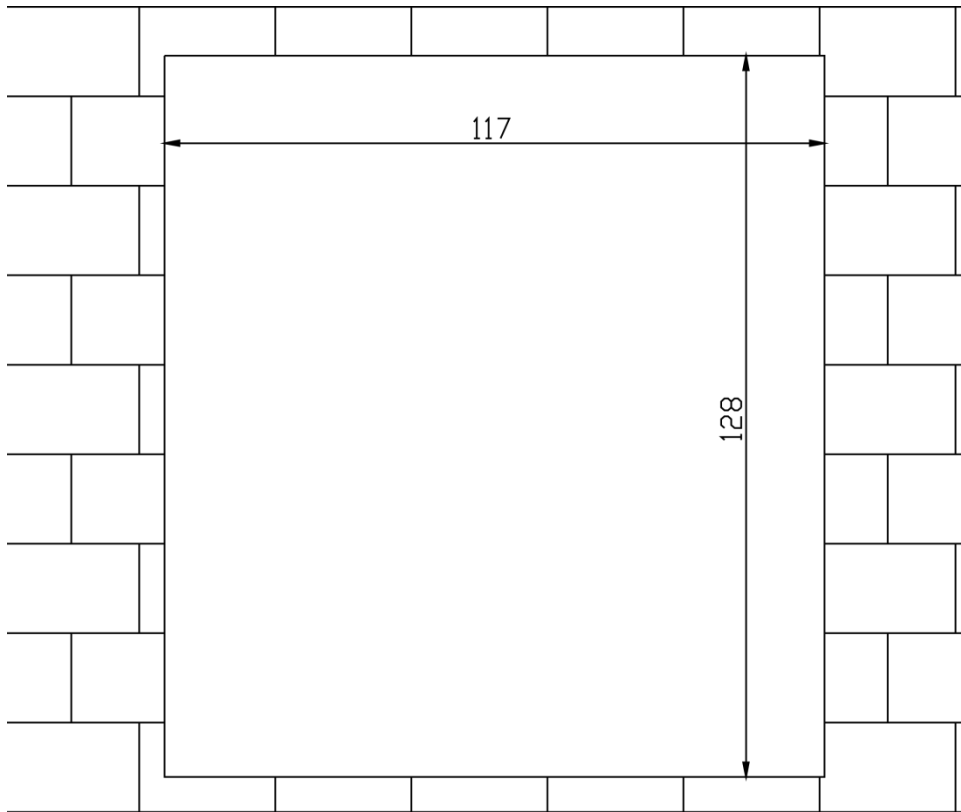

Figure 2- 5

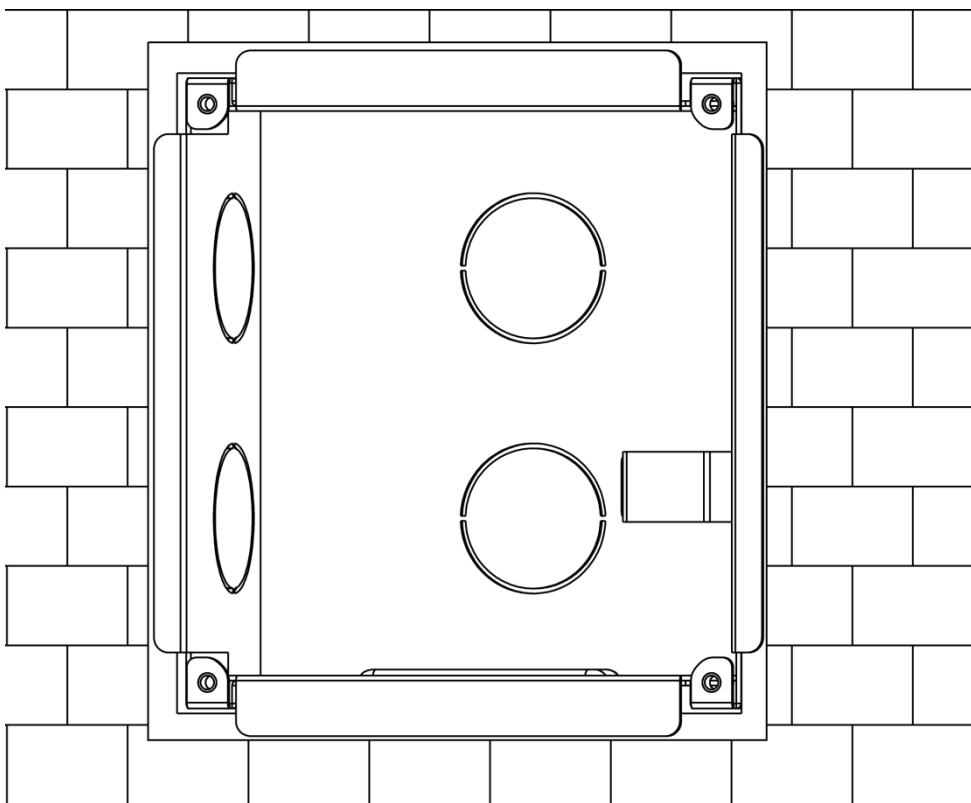

Figure 2- 6

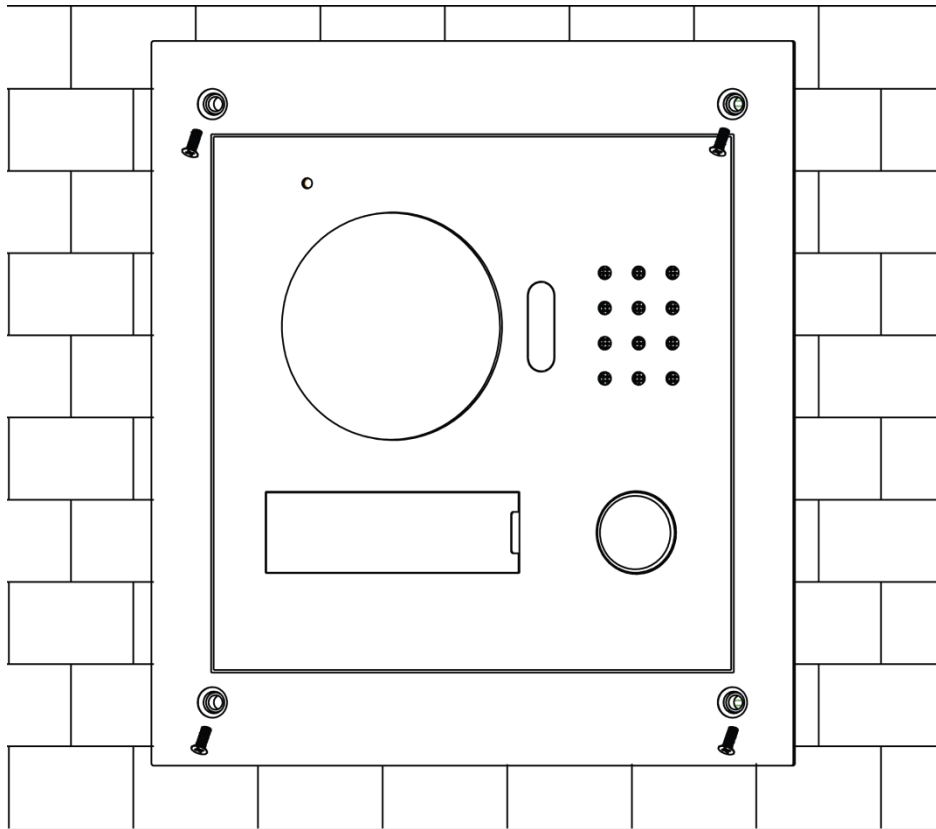

Figure 2- 7

## 2.3 Wiring

See Figure 2- 8.

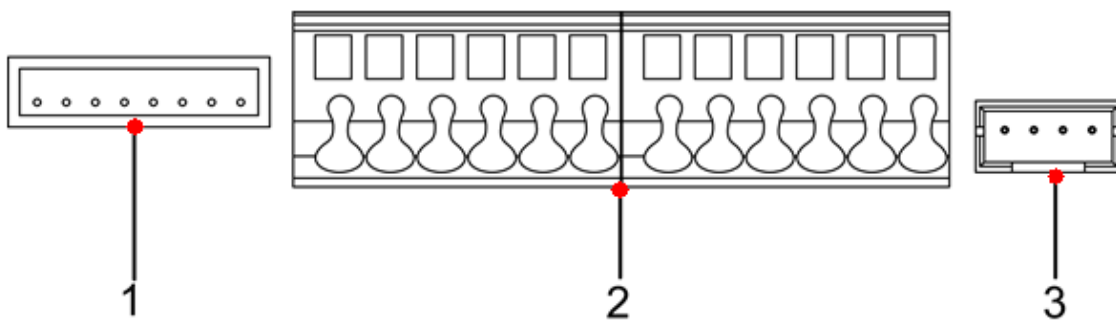

Figure 2- 8

No.	Component Name	Note
1	Network Port	Via convertor, connect to network cable. (RJ45 crystal head).

2	User Port	Power supply, connect to lock, door sensor and unlock button.
3	Project Port	Reserved for project staff use.

## 2.4 Electric Control Lock and Electromagnetic Lock

### 2.4.1 Electric Control Lock

When VTO connects to electric control lock, it means that the positive end of electronic control lock connects to NO of VTO (user port 10) while its negative end connects to COM of VTO (user port 12).

When VTO connects to unlock button, one end of unlock button connects to BUTTON of VTO (user port 7) while the other end connects to GND of VTO (user port 9). See Figure 2- 9.

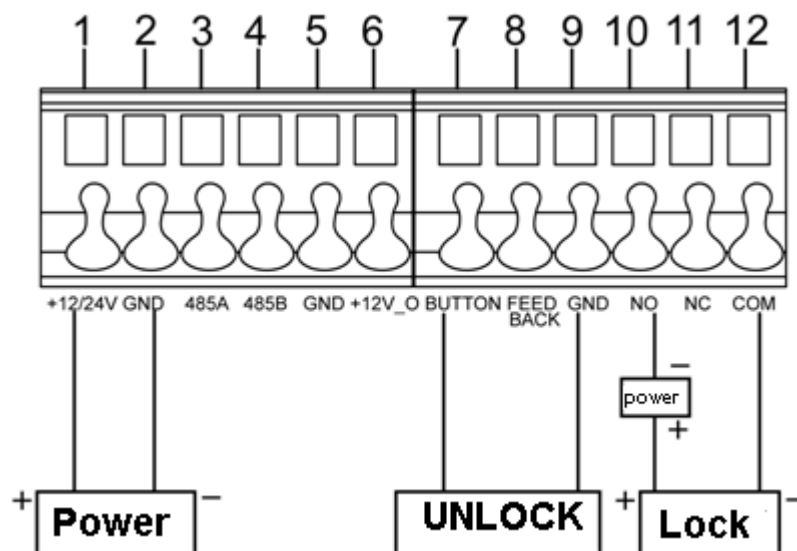

Figure 2- 9

### 2.4.2 Electromagnetic Lock

When VTO connects to electromagnetic lock, it means that the positive end of electromagnetic lock connects to NC of VTO (user port 11) while its negative end connects to COM of VTO (user port 12).

When VTO connects to door sensor in electromagnetic lock, one end of door sensor connects to FEEDBACK of VTO (user port 8) while the other end connects to GND of VTO (user port 9). See Figure 2- 10.

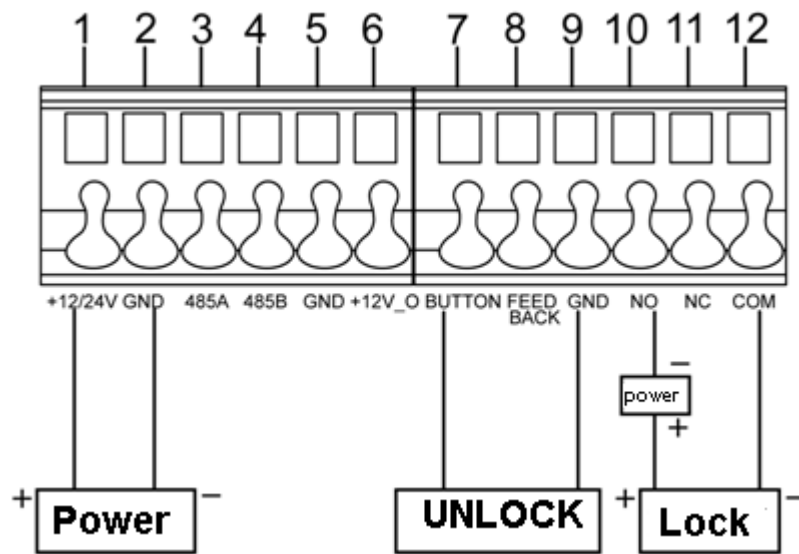

Figure 2- 10

## 3 Installation Debugging

### Warning:

- Before debugging, the staff shall be familiar with device's installation, wiring and usage.
- Before debugging, check wiring for short or open circuit.
- When staff find each circuit is normal, plug the device to power.
- After debugging, clear the site.

### 3.1 Modify IP Address

VTO default IP address is 192.168.1.110. Before using VTO, you shall modify VTO IP address to be designated IP address.

Step 1. Connect VTO to power.

About 60s after plugging to power, it auto boots up and enters working status. Name plate area indicator turns white.

Step 2. Via direction connection of Ethernet cable to connect device and PC, set PC IP address to be in the same network segment with VTO IP address.

Step 3. On PC, ping VTO IP command to check network.

If network is normal, then continue to Step 4; if network is abnormal, please check cable connection, IP address setup and device power.

Step 4. Login VTO WEB nterface, modify IP address.

1. In Internet Explorer address field, enter VTO IP address, system shows login interface.
2. Enter username and password, click "login", see Figure 3- 1.

Note:

Default username and password is admin and admin. After first time login, please modify your login password.



Figure 3- 1

3. Select System Config>Network, set VTO IP address, subnet mask and default gateway. Click OK, see Figure 3- 2.

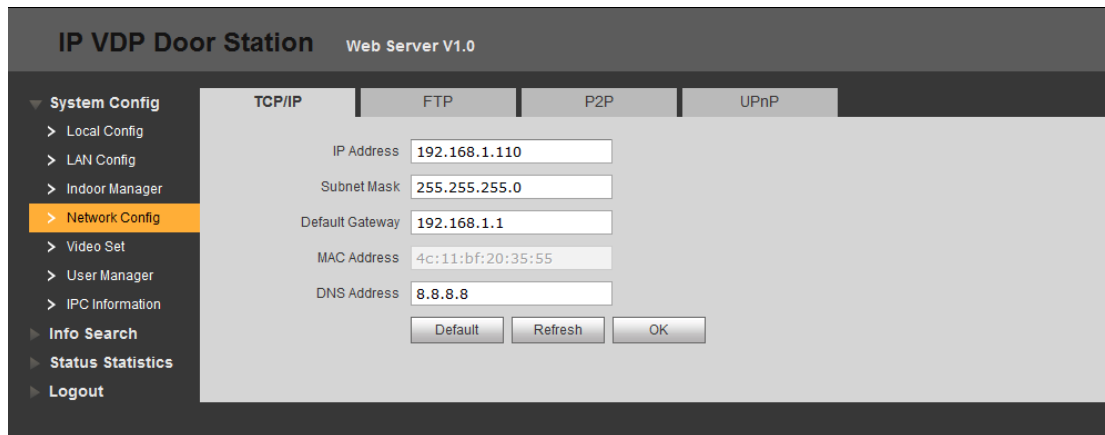

Figure 3- 2

## 3.2 General Config

If you first use VTO, you may need to operate according to the following steps:

- Step 1. In Internet Explorer, input IP address of the VTO, enter username and password, click Login to login WEB.

Note:

Default IP address of VTO is 192.168.1.110. Default username and password is admin/admin. After first login, please change your password.

- Step 2. In WEB interface, select System Config>Video Set, set video format as WVGA as in Figure 3- 3.

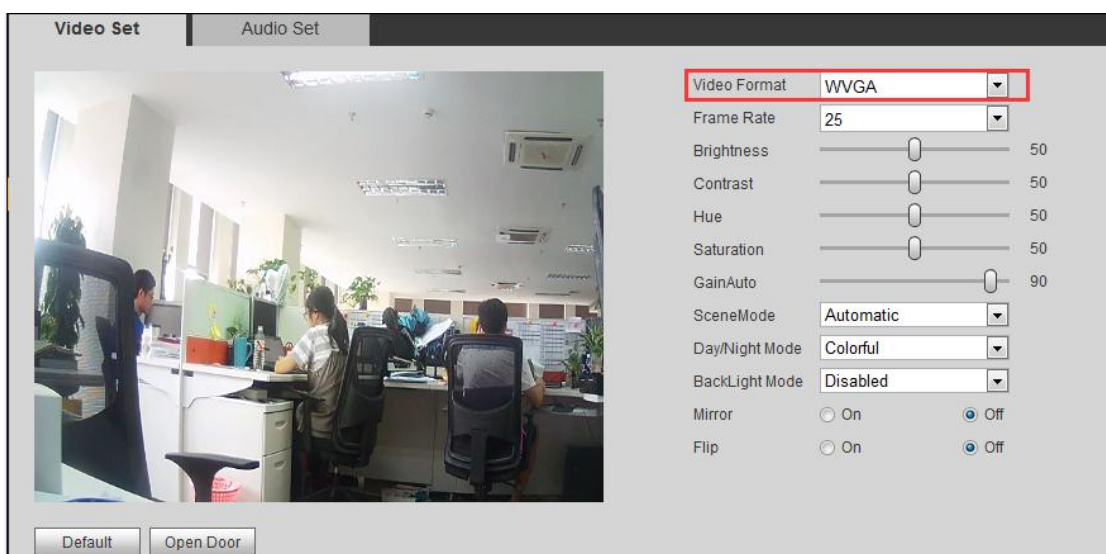

Figure 3- 3

- Step 3. In System Time tab, click on Sync PC to make VTO time the same with PC.
- Step 4. Select System Config>Network Config, set VTO IP, Subnet Mask and Default Gateway. See [错误!未找到引用源。](#) .

## 4 Web Config

This chapter introduces VTO WEB interface and its parameters, and how to configure them.

### 4.1 System Config

#### 4.1.1 Local Config

##### 4.1.1.1 Local Config

In Local Config interface, you can view VTO model, version info and etc.

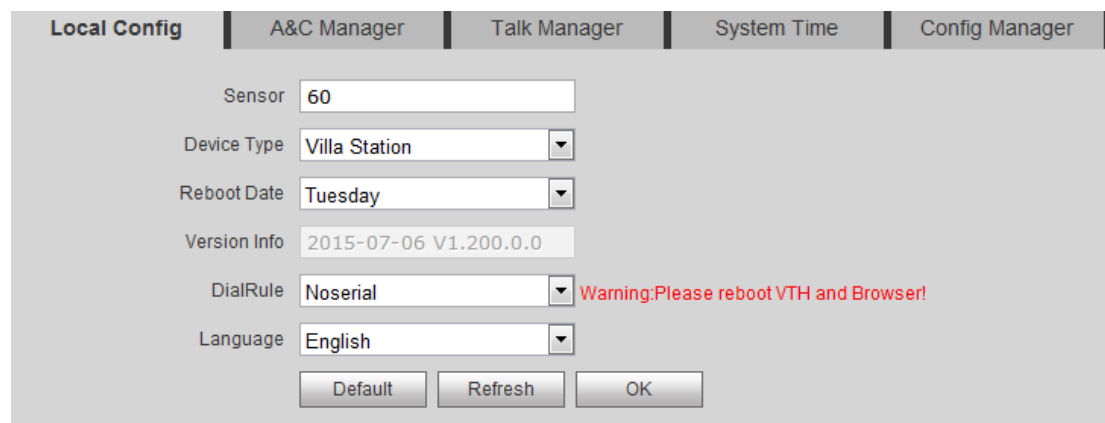

Figure 4- 1

Parameter	Note
Sensor	Set compensation light threshold.
Device Type	Display device type.
Reboot Date	On the set date, device will automatically reboot.
Version Info	Display device version info.
Default	Only restore current Local Config page to default settings.
Language	There are eight languages available.

##### 4.1.1.2 A&C Manager

A&C Manager mainly controls unlock responding interval time, unlock period and door sensor check time.

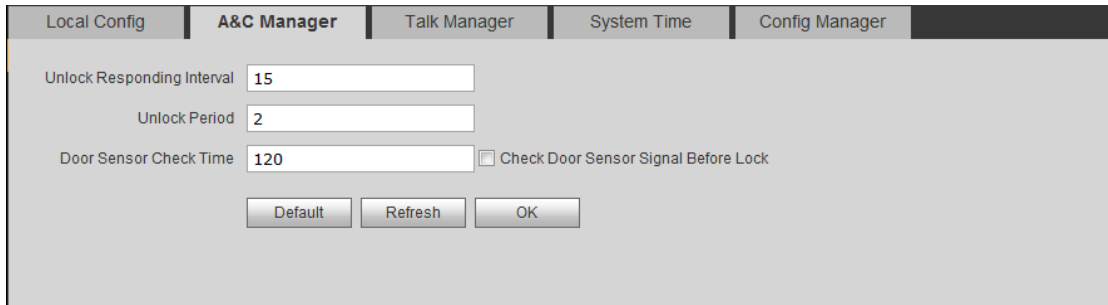

Figure 4- 2

Parameter	Note
Unlock Responding Interval	The interval between current unlock and next one, unit is second.
Unlock Period	Period door remains unlocked, unit is second.
Door Sensor Check Time	When only use door sensor, check"Check Door Sensor Signal Before Lock", Set "Door Sensor Check Time" to enable it.
Check Door Sensor Signal Before Lock	When door remains unlocked over set door sensor check time, it alarms.
Default	Only restore A&C Manager page to default settings.

#### 4.1.1.3 Talk Manager

The device supports talk management and you can enable and disable upload of talk call record, message and auto snapshot.

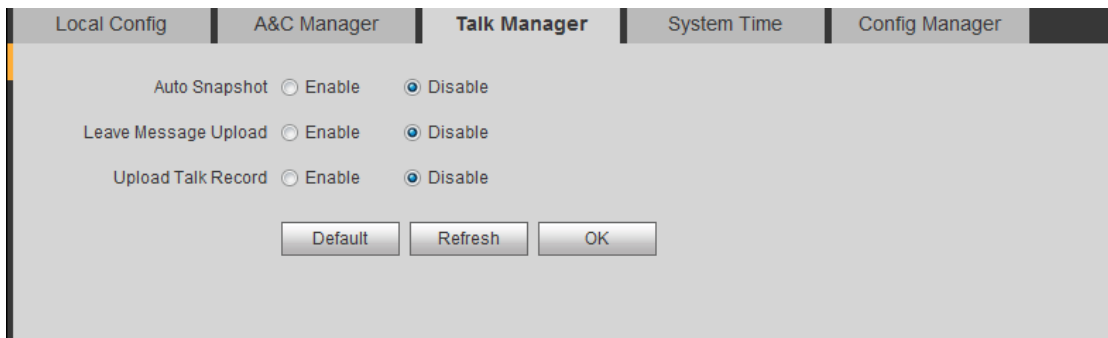

Figure 4- 3

#### 4.1.1.4 System Time

Here you can set date format, time format(24-hour and 12-hour), and input system date and time. You can also click on Sync PC to synchronize system time with PC time. You also can set DST start time.

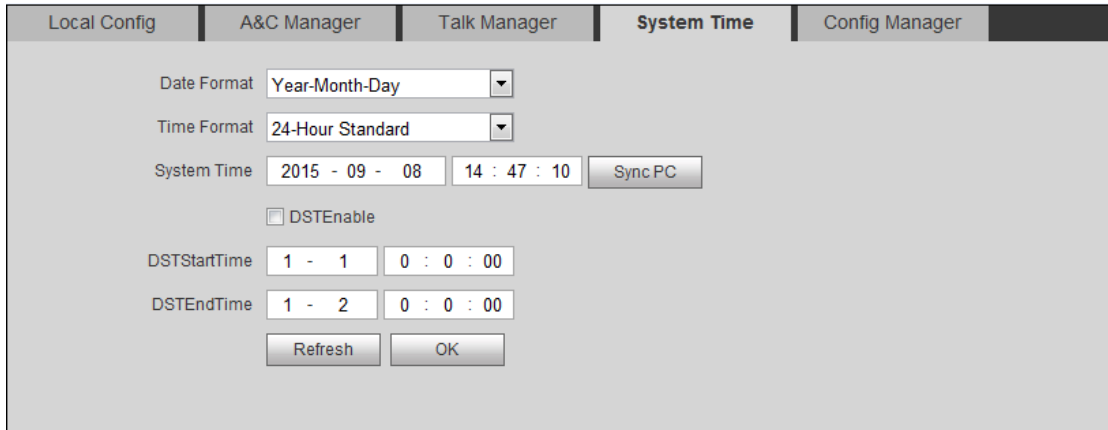

Figure 4- 4

#### 4.1.1.5 Config Manager

You can import and export configuration, or restore default setup.

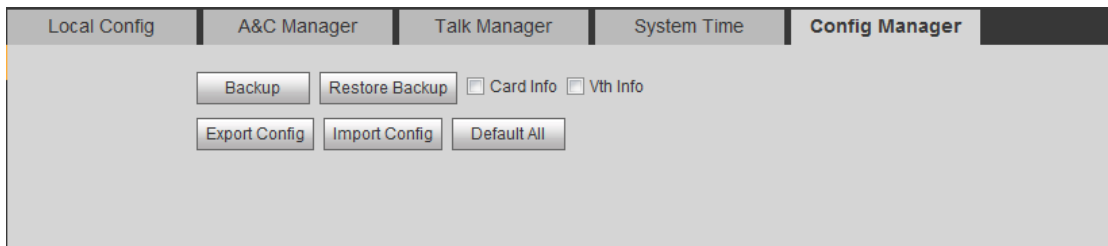
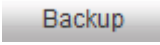
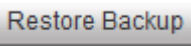

Figure 4- 5

Parameter	Note
Backup	Check “card no.”, “VTH info”, and click  , so you can back up card no. and VTH info.
Restore Backup	Check “card no.”, “VTH info”, and click  to recover card no. and VTH info.
Export	Export config file ( Config.backup )
Import	Import config file.
Default 置	Restore all parameters to default status. <b>Warning:</b> <b>Please back up parameters before restoring default settings!</b>

## 4.1.2 LAN Config

Here you can register VTO to center and set how to call center. Please refer to Ch 5.1.1.

## 4.1.3 Indoor Manager

In Indoor Manager interface, you can add, delete and modify VTH (digital indoor station),.

For example to add digital VTH:

Step 1. In tab, select System Config>Indoor Manager>Digital VTH Manager.

Step 2. Click .

Step 3. Fill in digital VTH basic info. See Figure 4- 6.

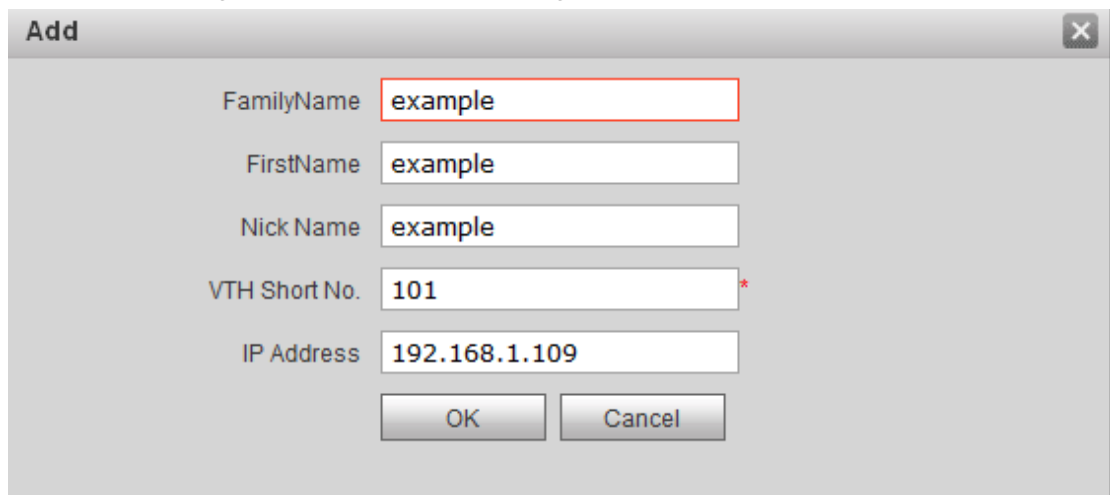

Figure 4- 6

Note:

Parameters with \* are mandatory.

Parameter	Note
VTH Short No.	VTH is indoor device, VTH no.
IP Address	Add VTH IP address.

Step 4. Click .

System displays interface when VTH is added. See Figure 4- 7.

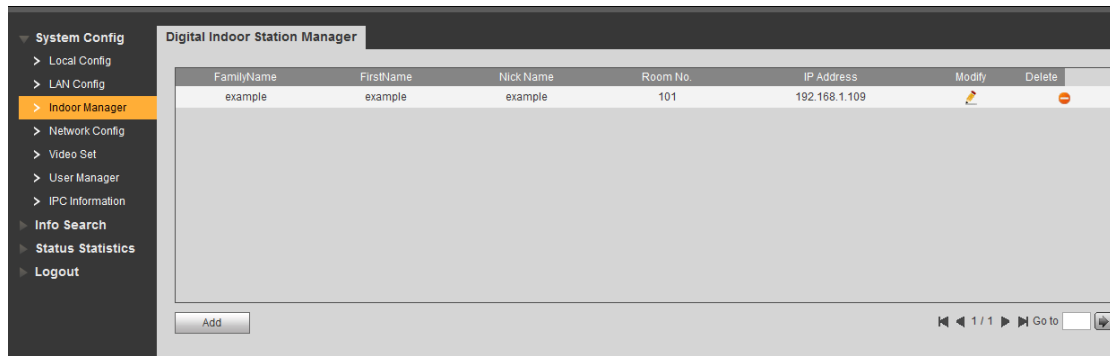



Figure 4- 7

- Click , in pop-up modification page modify VTH info.
  1. When you modify digital VTH, you can only modify name and nickname.
  2. When you modify analog VTH, you can only modify name, nickname, distributor address and distributor port.
- Click , delete digital VTH.

## 4.1.4 Network Config

### 4.1.4.1 TCP/IP

You can set local IP network parameter.

Step 1. Select System Config>Network>TCP/IP.

Step 2. Set local IP address, subnet mask and default gateway.

See Figure 4- 8.

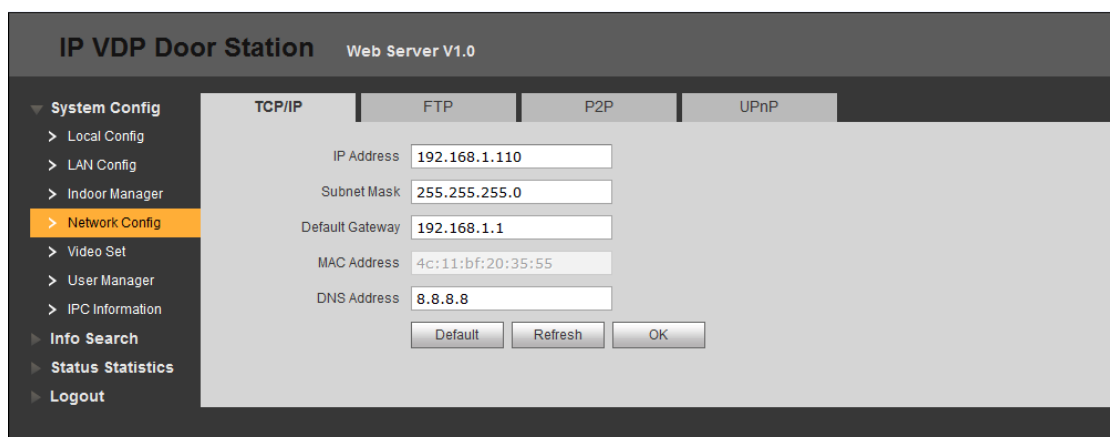

Figure 4- 8

Step 3. Click .

After you have modified IP address, WEB page will reboot and go to the new IP address page.

#### 4.1.4.2 FTP

FTP server is used to store record, snapshot picture and etc. User can login FTP server to view and get photo or image.

You can go to System Config>Network>FTP, to set local FTP network parameter.

See Figure 4- 9.

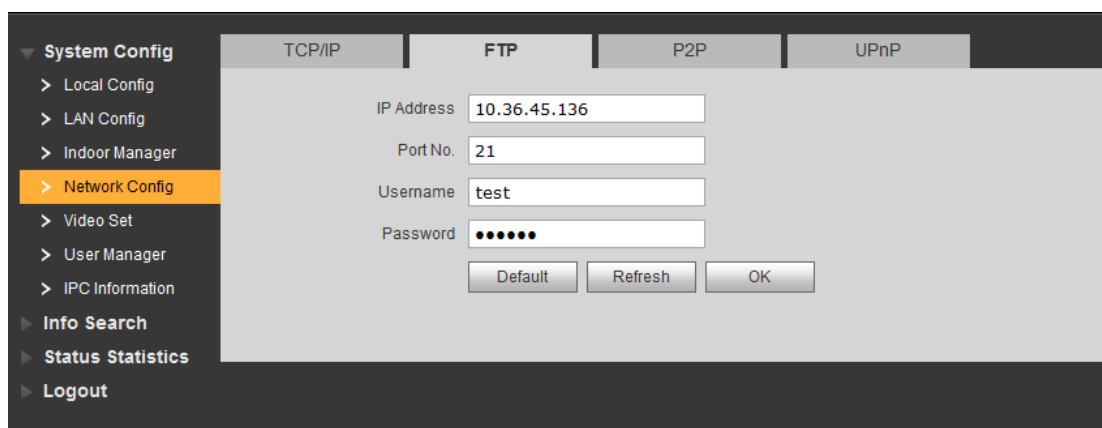

Figure 4- 9

#### 4.1.4.3 P2P

You can go to System Config>Network>P2P interface, select to enable P2P server, and view info by scanning the two-dimension code at bottom of interface. See Figure 4- 10.



Figure 4- 10

## 4.1.5 Video Set

You can go to System Config>Video Set interface to set video and audio.

Step 1. Select System Config>Video Set.

Step 2. Adjust video parameter. See Figure 4- 11.

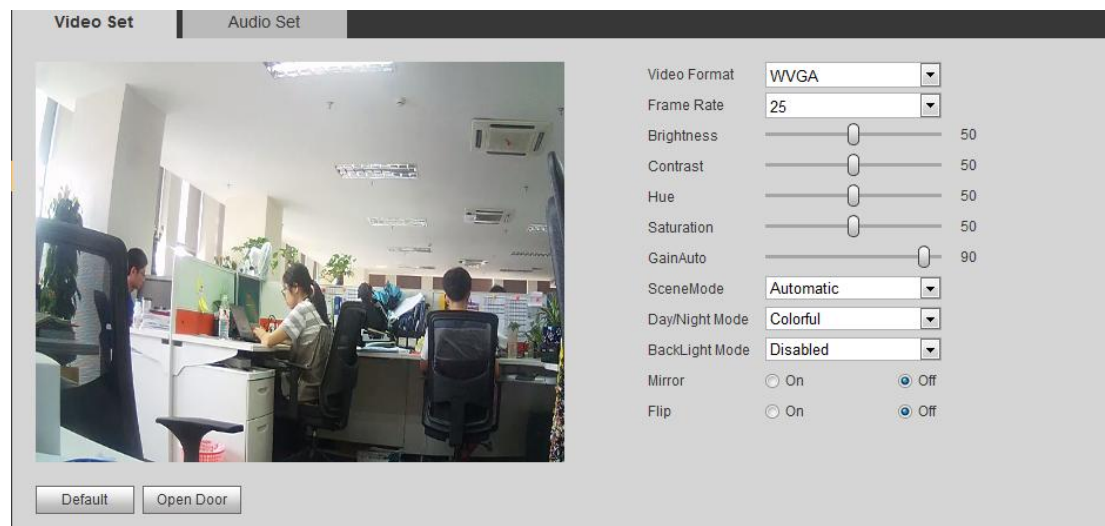

Figure 4- 11

Parameter	Note
Video Format	By resolution, there are WVGA and D1. WVGA: 800*480 pixels D1: 704*576 pixels.
Frame Rate	There are 25 and 30.
Brightness	Adjust video brightness, recommended value is 40~60, range is 0~100.
Contrast	Adjust video image contrast, recommended value is 40~60, range is 0~100.
Saturation	Adjust color saturation, recommended value is 40~60, range is 0~100.
Gain	Gain limit of video basic parameter.
Scene Mode	Select mode: automatic, sunny, night and etc.
Day/Night Mode	Include: color, auto and B/W.
Back Light Mode	Include: OFF, back light, WDR, HLC.
Mirror	Make image displayed in mirror.
Flip	Display image in flip.
Default	Reset video effect and volume to default.

Unlock	Unlock via web.
--------	-----------------

Step 3. Click audio setup tab, adjust audio parameter.

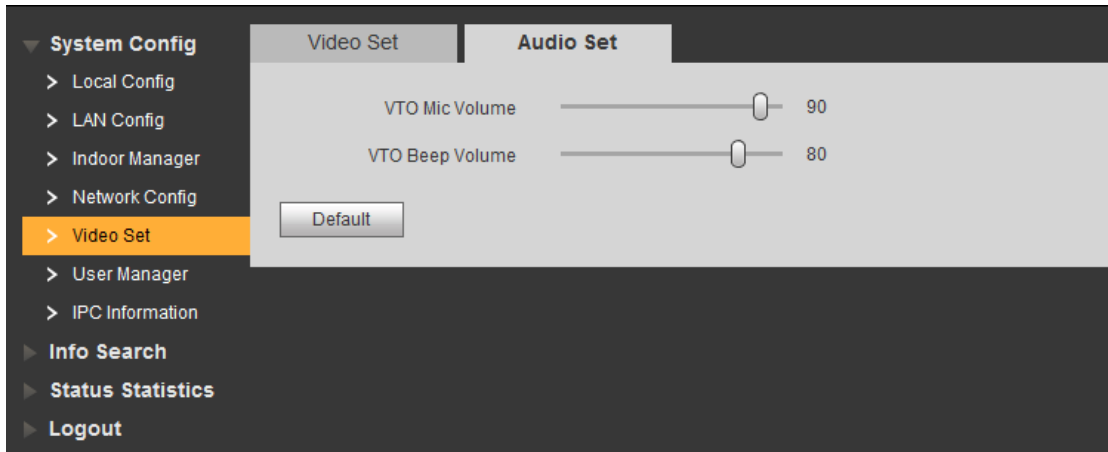

Figure 4- 12

## 4.1.6 User Manage

Only when you login as admin, you can add, modify, delete and view user info in User Manage interface.

Current system supports two types of user:

- Admin has higher right who can view, edit, delete configured right.
- User only can view system config.

### 4.1.6.1 Add User

Step 1. Select System Config>User Manager, system enters User Manager interface.

Step 2. Click Add.

Step 3. Configure user info to add. See Figure 4- 13.

Figure 4- 13

Step 4. Click .

#### 4.1.6.2 Modify User

Admin and user support to modify user password, but cannot modify note information or delete it.

Step 1. Select System Config>User Manager, enter User Manager interface. See Figure 4- 14.

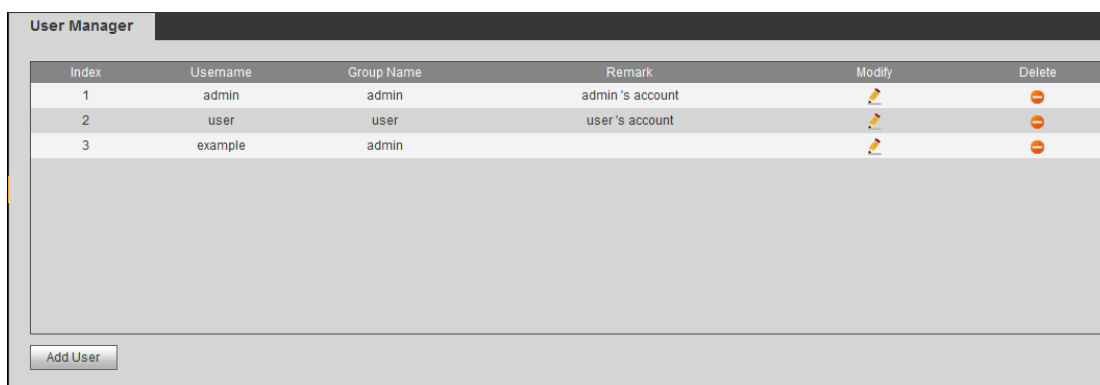

The screenshot shows the 'User Manager' interface. It features a table with columns for Index, Username, Group Name, Remark, Modify, and Delete. There are three rows of user data. Below the table is an 'Add User' button.







Index	Username	Group Name	Remark	Modify	Delete
1	admin	admin	admin's account		
2	user	user	user's account		
3	example	admin			

Figure 4- 14

Step 2. Click  to delete user.

Step 3. Click  to modify user info, check modify password, modify password and note info. See Figure 4- 15.

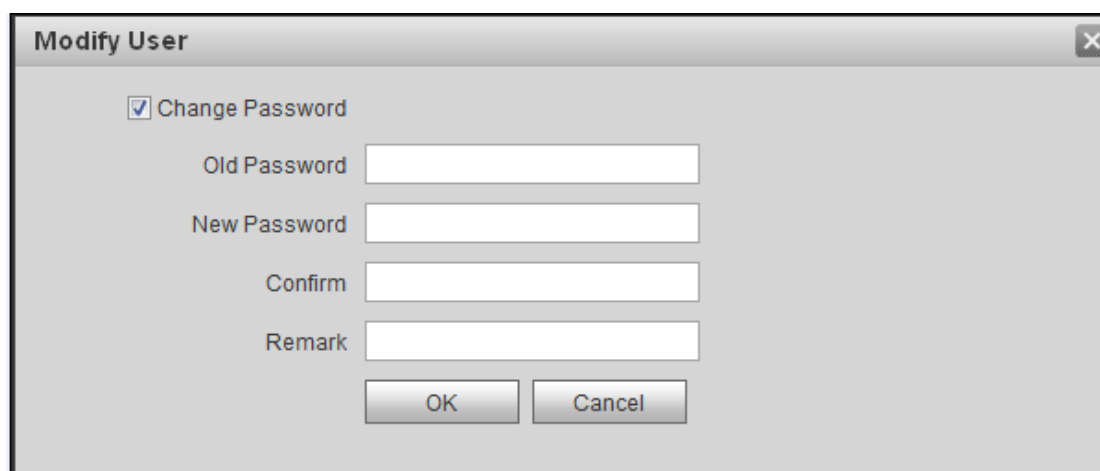

The 'Modify User' dialog box contains a checked checkbox for 'Change Password'. Below it are four text input fields: 'Old Password', 'New Password', 'Confirm', and 'Remark'. At the bottom are 'OK' and 'Cancel' buttons.

Change Password

Old Password

New Password

Confirm

Remark

Figure 4- 15

## 4.2 IPC

If the VTH has configured with IPC info, you can view IPC video image via corresponding VTH.

You can go to System Config>IPC info interface, view and modify all IPC info.

Step 1. Select System Config>IPC info.

Step 2. Click .

Step 3. Modify IPC info. See Figure 4- 16.

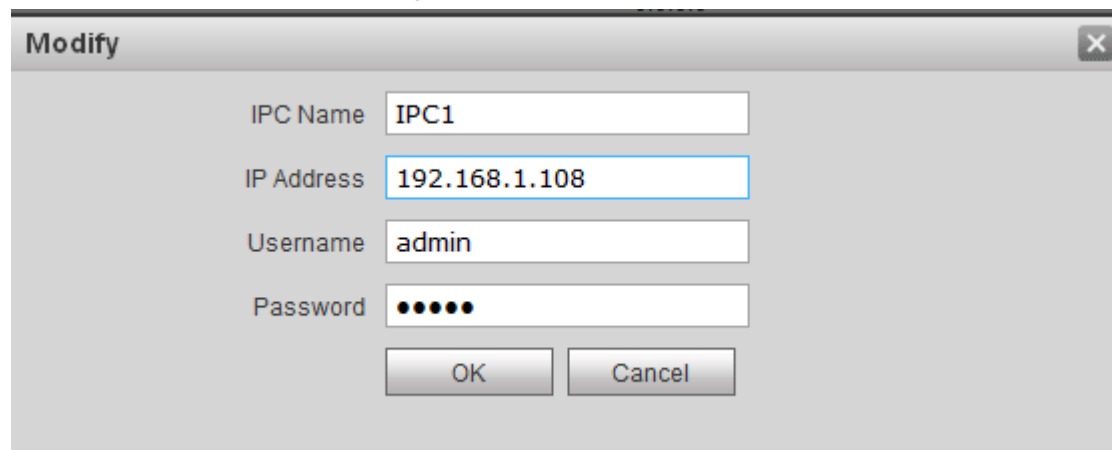

The screenshot shows a 'Modify' dialog box with the following fields and buttons:

IPC Name	IPC1
IP Address	192.168.1.108
Username	admin
Password	•••••

Buttons: OK, Cancel

Figure 4- 16

Step 4. Click .

## 4.3 Info Search

You can search and export VTP unlock, call and alarm record in Info Search interface.

### 4.3.1 Call History

You can search VTO call history in Call History interface, it stores up to 1024 records.  
See Figure 4- 17.

**VTO Call History**

Index	Call Type	Room No.	Begin Time	Talk Time(min)	End State
1	Outgoing	9901	2015-09-08 14:57:56	00:02	Received
2	Outgoing	9901	2015-09-02 14:33:51	00:00	Missed
3	Outgoing	9901	2015-09-01 17:53:35	00:00	Missed
4	Outgoing	9901	2015-09-01 17:06:04	00:00	Missed
5	Outgoing	9901	2015-09-01 16:27:15	00:00	Missed
6	Outgoing	9901	2015-09-01 16:26:17	00:00	Missed

Export Record 1 / 1 Go to

Figure 4- 17

### 4.3.2 Alarm Record

You can search VTO alarm in Alarm Record interface, and it stores up to 1024 records.

**Alarm Record**

Index	Room No.	Event State	Channel	Begin Time
-------	----------	-------------	---------	------------

Figure 4- 18

### 4.3.3 Unlock Record

You can search VTO unlock records in Unlock Record interface, and it stores up to 1024 records.

**VTO Unlock Record**

Index	Unlock Type	Room No.	Card Number	Unlock Result	Unlock Time
1	Remote Unlock	9901		Success	2015-09-02 14:59:37

Figure 4- 19

## 4.4 Status Statistics

### 4.4.1 VTH Status

In VTH status, you can view VTH connection status.

- Status

Offline: Connection between VTO and VTH is disconnected; you cannot call, monitor or talk.

Online: Connection between VTO and VTH is ready, you can call, monitor and talk.

- Monitor Status

Unmom: VTH is not monitoring.

Onmom: VTH is monitoring.

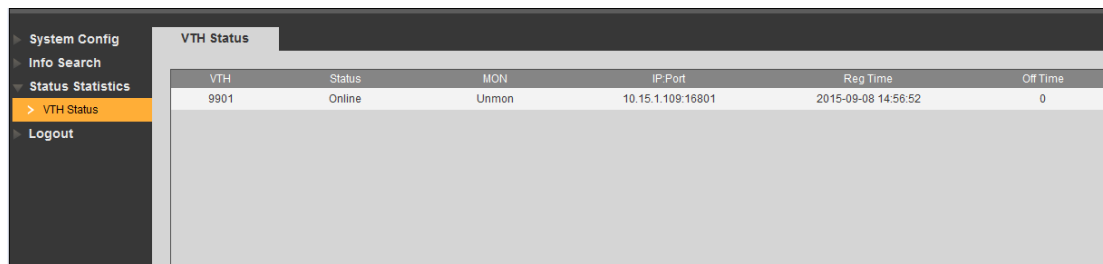

VTH	Status	MON	IP:Port	Reg Time	Off Time
9901	Online	Unmom	10.15.1.109:16801	2015-09-08 14:56:52	0

Figure 4- 20

## 4.5 Logout

In Logout, you can reboot device or logout.

Click on logout to log out the system and it returns to login page.

## 5 Basic Function Introduction

### 5.1 Call Function

#### 5.1.1 Call Resident

Press Call button under standby status, and the VTO will call user. User may monitor VTO from VTH.

- On VTH, press Unlock button to unlock door.
- When VTH picks up, you can start talk with the VTH.
- If no one answers the call, then the call will end automatically and device returns to standby status.

#### 5.1.2 Group Call

Group call is mainly used for one VTO. Press Call button on VTO to call multiple VTH at the same time. A resident can answer, hang up and unlock on any one unit of VTH. VTH consists of master VTH and extension VTH. A system can only have a max of 1 master VTH and 3 extension VTHs.

#### Set VTO

Step 1. Select System Config>Indoor Manager.

Step 2. Click  in Indoor Manager interface to delete default VTH9901.

Step 3. Click Add, input VTH short no., input IP address (optional) to add one VTH.

Note:

In Indoor Manager interface, only need to add main VTH.

See Figure 5- 1.

The 'Add' dialog box contains the following fields and values:

- FamilyName: example
- FirstName: example
- Nick Name: example
- VTH Short No.: 101\*
- IP Address: 192.168.1.109

Buttons: OK, Cancel

Figure 5- 1

**Note:**

Parameter with \* is mandatory, while others are optional.

Step 4. In LAN Config interface, check group call, click OK.

Step 5. After config is complete, enter logout interface, reboot VTO.

See Figure 5- 2.

The 'LAN Config' interface contains the following fields and values:

- Building No.: 01
- Building Unit No.: 1
- VTO No.: 6901
- Max Extension Index: 5
- MGT Centre IP Address: 10.22.5.254
- MGT Port No.: 12801
- Call VTS Time: 00:00 To 23:59

Checkboxes:  Group Call,  Register to the MGT Centre

Warning: The device needs reboot after modifying the config above.  
If extensionCount changed, need reboot VTH and init VTH information again!

Buttons: Default, Refresh, OK

Figure 5- 2

**Configure Main VTH**

Step 1. In VTH screen, press System Config, and press Project settings, input password (default is 002236), and enter Project settings interface.

Step 2. Press Local Info, input room no., local IP, subnet mask, see Figure 5- 3 and Figure 5- 4.

**Note:**

Room no. must match VTH short no. in Figure 5- 2.

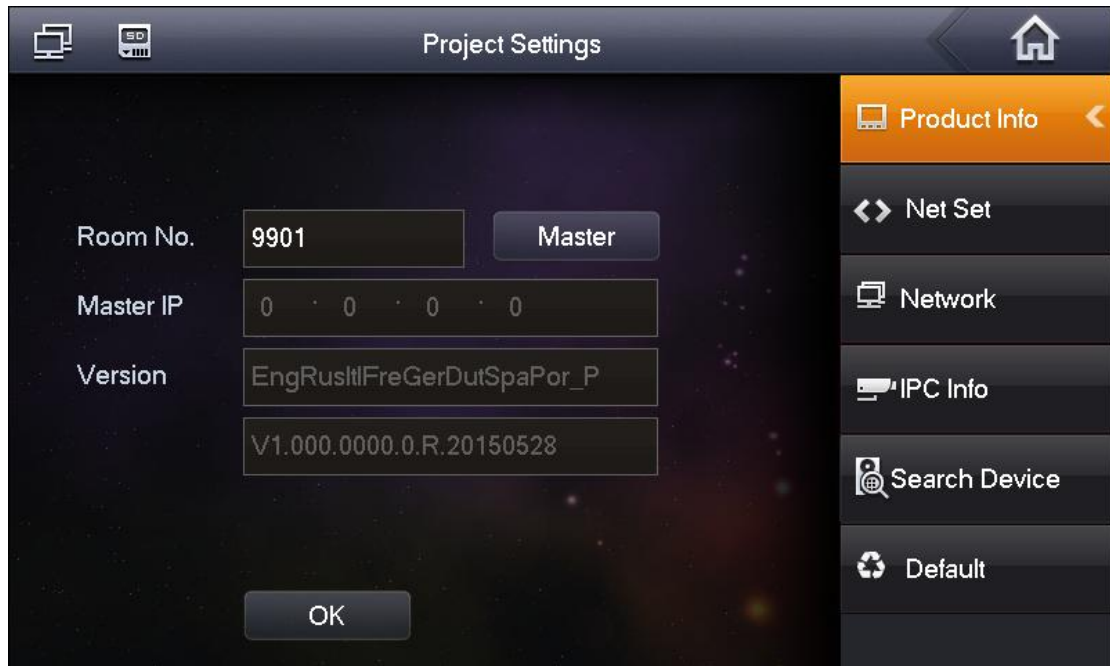

Figure 5- 3

Step 3. Press network, fill in VTO IP address.

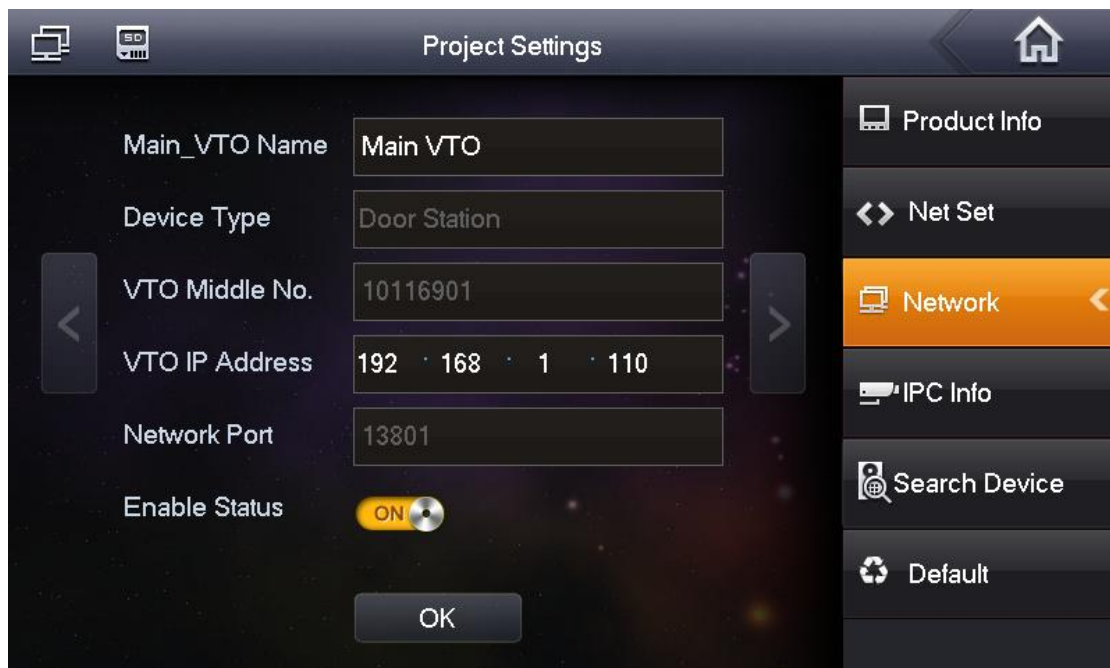

Figure 5- 4

**Set Extension**

- Step 1. In VTH screen, press System Config, and press project settings, input password (default is 002236), and enter project settings interface.
- Step 2. Press local info. Press master and it changes to extension.
- Step 3. Set room no., fill in local IP, subnet mask and gateway.
- Step 4. In master IP fill in main VTH IP. After setup is complete, extension will auto synv

with user config on the main VTH.

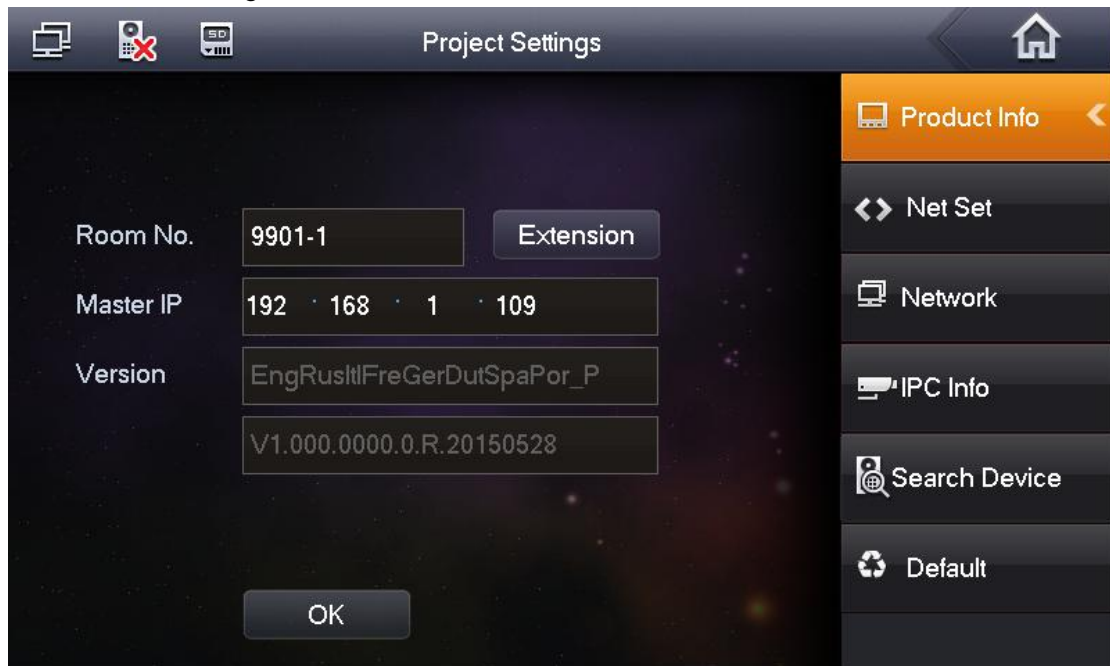

Figure 5- 5

## 5.2 Monitor

Both VTS and VTH are able to monitor this VTO and remotely view camera captured image on VTH.

## 5.3 Unlock Function

### Unlock by Center

When center is called, calling or monitoring, center can remotely unlock door. VTO will return to standby interface after call ends or countdown stops.

### Unlock by VTH

When VTH is called, calling or monitoring, VTH can remotely unlock door. VTO will return to standby interface after call ends or countdown stops.

## 5.4 Compensation of Light

In dark environment or at night, the VTO adopts auto photoreception technology which

achieves light compensation in connecting status.

## 5.5 Vandal Proof

There is one channel of vandal proof which will generate alarm sound and report to the manager center once VTO is forced to leave the wall.

## 5.6 Restore Backup

### Restore Card Info

If you encounter abnormality with card info or accidentally restore default settings, you can restore card info with this function.

### Restore VTH Info

If VTH info is mistakenly changed, you can restore VTH info with this function.

**Note: Every half hour, VTO automatically saves card and VTH info in the system. If you want to restore card and/or VTH info, you must restore within half hour after your last operation that change these info.**

## 6 FAQ

1. Q: I pressed Call button, and the indicator turned on, but the VTO did not start a call?  
A: Please check your operation process.
2. Q: How to end a call when I am calling?  
A: Please press button on VTO and there will be sound from the device.
3. Q: The device could not boot up and there was no sound or light.  
A: Please check if power supply is well plugged.
4. Q: My call did not go though.  
A: It is network connection error; please check the cables of the device and its extension.
5. Q: Volume is too low.  
A: Adjust the VTO and VTH call volume.
6. Q: The device does not boot up.  
A: Check the power supply between VTH and VTO.
7. Q: VTH does not show video or video quality is poor.  
A: Go to VTO WEB page, switch video format to WVGA and avoid placing VTO under poor light or direct sunlight.
8. Q: The device cannot unlock.  
A: Check A&C module on VTH for loosened wiring, and check electric lock (incorrect wiring, no output voltage or low output voltage).
9. Q: I have other problems not included above.  
A: Please contact technical staffs for assistance.

## Appendix 1 Technical Specifications

Model		INTIPRDSVW
System	Main Process	Embedded micro controller
	OS	Embedded Linux os
Video	Video Compression Standard	H.264
	Input/Sensor	Megapixel CMOS HD camera
	Night Vision	Support
Audio	Input	Omnidirectional Mic
	Output	Built-in speaker
	Talk	Support bidirectional talk
Operation Mode	Input	Single key input
	Door Lock Status Check	Support (optional)
Network	Ethernet	10M/100Mbps self-fit
	Network Protocol	TCP/IP
General	Power	DC 10V~15V
	Consumption	Standby ≤1W; working ≤10W
	Working Temperature	- 30°C ~+70°C
	Relative Humidity	10%~90%RH
	Dimension (LxWxH)	129.9mm×32.2mm×140mm
	Wight	0.8kg

## Appendix 2 Accessories

### Appendix 2.1 Cable Specification

The wiring length between VTO and VTH is  $L_N$ , so reasonable specification of wiring is:

Cable Specification	$0 < L_N \leq 50\text{m}$	$50 < L_N \leq 100\text{m}$
UTP Cat5e/Cat6: 10 ohm/100m	Optional	Optional
UTP Cat5e/Cat6: 18.8 ohm/100m	Optional	Not optional

Note:

Please do not let  $L_N$  be over 100m.

### Appendix 2.2 Power Extension Line Specification

The wiring length between VTO and adaptor is  $L_C$ , so reasonable specification of extension line is:

Extension Line Specification	$0 < L_C \leq 30\text{m}$	$30 < L_C \leq 100\text{m}$
20AWG	Optional	Not optional
18AWG	Optional	Optional
17AWG	Optional	Optional

Note:

Before plugging extension line to power, make sure its positive and negative end are correctly wired.

### Appendix 2.3 Embedded Box

VTO Model	Embedded Box
INTIPRDSVW	Case 126*115

**Note:**

- **This manual is for reference only. Slight difference may be found in user interface.**
- **All the designs and software here are subject to change without prior written notice.**
- **All trademarks and registered trademarks are the properties of their respective owners.**
- **If there is any uncertainty or controversy, please refer to the final explanation of us.**
- **Please visit our website or contact your local service engineer for more information.**